

HA 系列 / HA SERIES

技术参数 Technical Characteristics

规范	Specifications	
规范	Specifications	DIN EN 60 664
		DIN EN 61 984
插芯	Inserts	
接插件针数	Number Of Contacts	3,4,10,16,32(2X16)+PE
HA-003/004		
额定电流	Rated Current	10A
相对地额定电压	Rated Voltage Conductor-ground	230V
相间额定电压	Rated Voltage Conductor-conductor	400V
额定脉冲电压	Rated Impulse Voltage	4kV
污染程度	Pollution Degree	3
或	Or	10A 250V 4kV 3
HA-010/016		
额定电流	Rated Current	16A
额定电压	Rated Voltage	250V
额定脉冲电压	Rated Impulse Voltage	4kV
污染程度	Pollution Degree	3
污染等级2时的参数	Pollution Degree 2 Also	16A 230/400V 4kV 2
依据UL/CSA额定电压	Rated Voltage Acc.to UI Csa	600V
绝缘电阻	Insulation Resistance	$\geq 10^{10} \Omega$
材料	Material	聚碳酸酯 Polycarbonate
工作温度范围	Limiting Temperatures	-40°C...+125°C
阻燃等级	Flammability Acc. To UI94	V0
可拔插次数	Mechanical Working Life-mating Cycles	≥ 500
插针	Contacts	
材料	Material	铜合金 Copper Alloy
表面处理	Surface	镀金 Hard-gold Plated 镀银 Hard-silver Plated
接触电阻	Contact Resistance	$\leq 1m\Omega$
螺钉连接	Screw Terminal	
导线规格	Wire Gauge	1.0-2.5mm ²
AWG	Awg	18-14
拧紧力矩	Tightening Torque	0.25Nm (HA-003/004) or 0.5Nm (HA-010/016)
冷压连接	Crimp Terminal	
-导线规格	Wire Gauge	0.14-4.0mm ²
-AWG	Awg	26-12
弹片连接	Cage-clamp	
导线规格	Wire Gauge	0.14-2.5mm ²
AWG	Awg	26-14

电流负载能力 Current Carrying Capacity

电流负载能力所受的限制主要来自包含接插针的接插体可承受的最大温度

The current carrying is limited by maximum temperature of materials for Inserts and contacts including terminals.

测试和控制过程依据 Measuring and testing techniques according to DIN EN 60512-5

①线径 Wire gauge: 2.5mm² ②线径 Wire gauge: 1.5mm² ③线径 Wire gauge: 1.0mm²

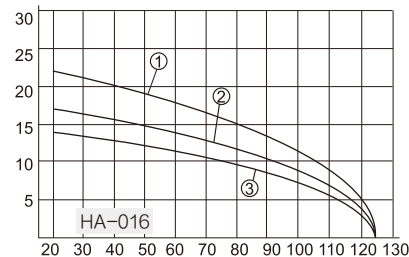
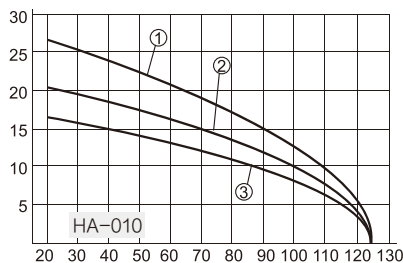
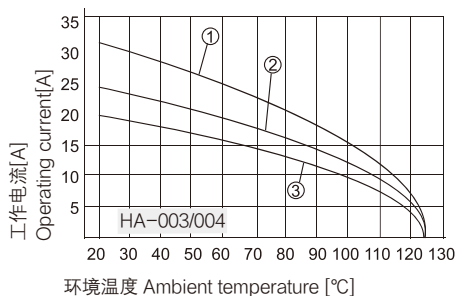

插芯 Inserts

外壳尺寸：匹配3A外壳，详情请参考11-05~11-11页

Hoods/Housings：Matching 3A Hood Housing，detail on P11-05~P11-11

螺丝连接 Screw terminal



插芯 Inserts	型号 Type	订货号 Part Number
公 Male	HA-003-M	09200032611
母 Female	HA-003-F	09200032711

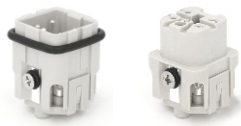
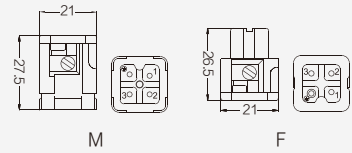

公 Male	HA-004-M	09200042611
母 Female	HA-004-F	09200042711

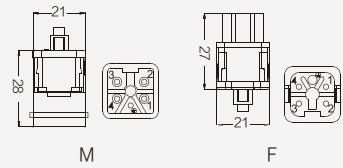

弹片连接 Cage-clamp



插芯 Inserts	型号 Type	订货号 Part Number
公 Male	HA-003-MS	09200032633
母 Female	HA-003-FS	09200032733

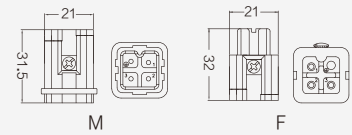

公 Male	HA-004-MS	09200042633
母 Female	HA-004-FS	09200042733

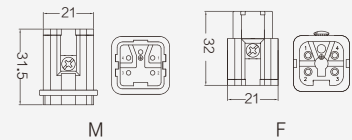



HA-010 小型插芯 The Slim Inserts 230/400V 16A 10+⊕

插芯 Inserts

外壳尺寸：匹配10A外壳，详情请参考12-01~12-02页

Hoods/Housings：Matching 10A Hood Housing，detail on P12-01~P12-02

螺丝连接 Screw terminal



插芯 Inserts	型号 Type	订货号 Part Number
公 Male	HA-010-M	09200102612
母 Female	HA-010-F	09200102812

1) 接插体之间的最大距离24mm

1) Distance for contact max.24mm

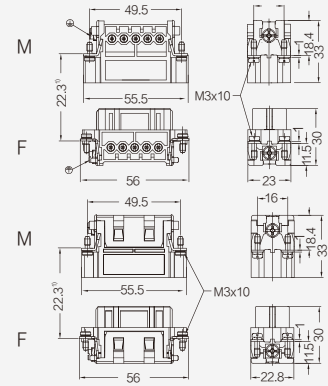

接插针排序

Contacts arrangement view from termination side

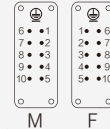

面板安装开孔图

Panel cut out for Inserts for use without Hoods/housings

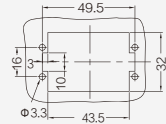

冷压连接 Crimp terminal



插芯 Inserts	型号 Type	订货号 Part Number
公 Male	HA-010-MC	09200103001
母 Female	HA-010-FC	09200103101

附件 Accessories

16A 冷压针 Crimp contacts

接触电阻 Contact resistance $\leq 1\text{m}\Omega$
镀银 Silver plated



公 Male	订货号 Part Number	母 Female	订货号 Part Number
CESM-0.37	09330006127	CESF-0.37	09330006227
CESM-0.5	09330006121	CESF-0.5	09330006220
CESM-0.75	09330006114	CESF-0.75	09330006214
CESM-1.0	09330006105	CESF-1.0	09330006205
CESM-1.5	09330006104	CESF-1.5	09330006204
CESM-2.5	09330006102	CESF-2.5	09330006202
CESM-3.0	09330006106	CESF-3.0	09330006206
CESM-4.0	09330006107	CESF-4.0	09330006207

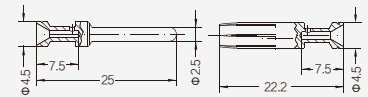

镀金 Gold plated



公 Male	订货号 Part Number	母 Female	订货号 Part Number
CEGM-0.37	09330006117	CEGF-0.37	09330006217
CEGM-0.5	09330006122	CEGF-0.5	09330006222
CEGM-0.75	09330006115	CEGF-0.75	09330006215
CEGM-1.0	09330006118	CEGF-1.0	09330006218
CEGM-1.5	09330006116	CEGF-1.5	09330006216
CEGM-2.5	09330006123	CEGF-2.5	09330006223
CEGM-4.0	09330006119	CEGF-4.0	09330006221

标示 Identification	线规 Wire gauge	剥线长度 Stripping length	
no groove	0.14-0.37mm ²	AWG 26-22	7.5mm
no groove	0.5mm ²	AWG 20	7.5mm
1 groove	0.75mm ²	AWG 18	7.5mm
1 groove	1.0mm ²	AWG 18	7.5mm
2 groove	1.5mm ²	AWG 16	7.5mm
3 groove	2.5mm ²	AWG 14	7.5mm
wide groove	3mm ²	AWG 12	7.5mm
no groove	4mm ²	AWG 12	7.5mm

工具 Tools

冷压钳 Crimping tool



压接线经 Wire gauge	型号 Type	订货号 Part Number
0.5-4mm ²	TL02G	09990000021

退针器 Removal tool



适用类型 For	型号 Type	订货号 Part Number
16A 冷压针 16A Crimp contacts	TL01	09990000059

更多工具请参考 25-01~25-02页 More tools on P25-01~P25-02

HA-016 小型插芯 The Slim Inserts 250V 16A 16+

插芯 Inserts

外壳尺寸：匹配16A外壳，详情请参考13-01~13-02页

Hoods/Housings : Matching 16A Hood Housing , detail on P13-01~P13-02

螺丝连接 Screw terminal



插芯 Inserts	型号 Type	订货号 Part Number
公 Male	HA-016-M	09200162612
母 Female	HA-016-F	09200162812

冷压连接 Crimp terminal

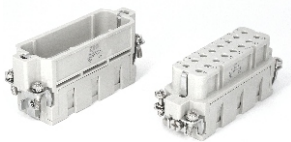

插芯 Inserts	型号 Type	订货号 Part Number
公 Male	HA-016-MC	09200163001
母 Female	HA-016-FC	09200163101

1) 接插体之间的最大距离24mm

1) Distance for contact max.24mm

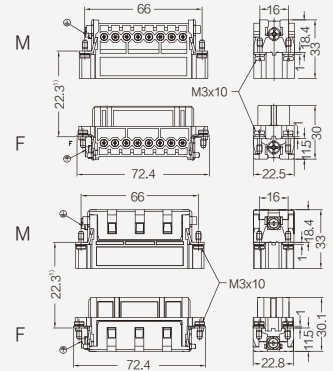

接插针排序

Contacts arrangement view from termination side

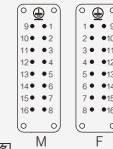

面板安装开孔图

Panel cut out for Inserts for use without Hoods/housings

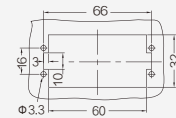

附件 Accessories

16A 冷压针 Crimp contacts

接触电阻 Contact resistance $\leq 1m\Omega$
镀银 Silver plated



公 Male	订货号 Part Number	母 Female	订货号 Part Number
CESM-0.37	09330006127	CESF-0.37	09330006227
CESM-0.5	09330006121	CESF-0.5	09330006220
CESM-0.75	09330006114	CESF-0.75	09330006214
CESM-1.0	09330006105	CESF-1.0	09330006205
CESM-1.5	09330006104	CESF-1.5	09330006204
CESM-2.5	09330006102	CESF-2.5	09330006202
CESM-3.0	09330006106	CESF-3.0	09330006206
CESM-4.0	09330006107	CESF-4.0	09330006207

镀金 Gold plated



公 Male	订货号 Part Number	母 Female	订货号 Part Number
CEGM-0.37	09330006117	CEGF-0.37	09330006217
CEGM-0.5	09330006122	CEGF-0.5	09330006222
CEGM-0.75	09330006115	CEGF-0.75	09330006215
CEGM-1.0	09330006118	CEGF-1.0	09330006218
CEGM-1.5	09330006116	CEGF-1.5	09330006216
CEGM-2.5	09330006123	CEGF-2.5	09330006223
CEGM-4.0	09330006119	CEGF-4.0	09330006221

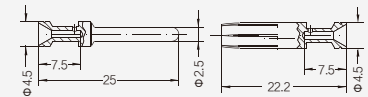

标示 Identification	线规 Wire gauge	剥线长度 Stripping length	
no groove	0.14~0.37mm ²	AWG 26~22	7.5mm
no groove	0.5mm ²	AWG 20	7.5mm
1 groove	0.75mm ²	AWG 18	7.5mm
1 groove	1.0mm ²	AWG 18	7.5mm
2 groove	1.5mm ²	AWG 16	7.5mm
3 groove	2.5mm ²	AWG 14	7.5mm
wide groove	3mm ²	AWG 12	7.5mm
no groove	4mm ²	AWG 12	7.5mm

工具 Tools

冷压钳 Crimping tool



压接线径 Wire gauge	型号 Type	订货号 Part Number
0.5~4mm ²	TL02G	09990000021

退针器 Removal tool



适用类型 For	型号 Type	订货号 Part Number
16A 冷压针 16A Crimp contacts	TL01	09990000059

更多工具请参考 25-01~25-02页 More tools on P25-01~P25-02

插芯 Inserts

外壳尺寸：匹配32A外壳，详情请参考14-01~14-02页

Hoods/Housings：Matching 32A Hood Housing，detail on P14-01~P14-02

螺丝连接 Screw terminal

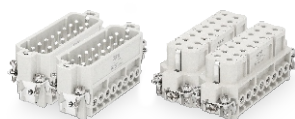

插芯 Inserts	型号 Type	订货号 Part Number
公 Male	HA-016-M(1-16)	09200162612
	HA-016-M(17-32)	09200162613
母 Female	HA-016-F(1-16)	09200162812
	HA-016-F(17-32)	09200162813

冷压连接 Crimp terminal

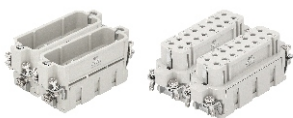

插芯 Inserts	型号 Type	订货号 Part Number
公 Male	HA-016-MC(1-16)	09200163001
	HA-016-MC(17-32)	09200163011
母 Female	HA-016-FC(1-16)	09200163101
	HA-016-FC(17-32)	09200163111

1) 接插体之间的最大距离24mm

1) Distance for contact max.24mm

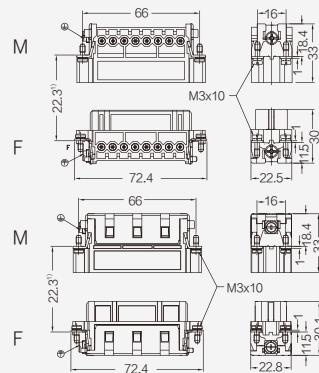

接插针排序

Contacts arrangement view from termination side

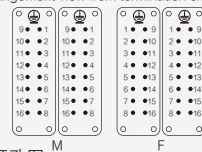

面板安装开孔图

Panel cut out for Inserts for use without Hoods/housings

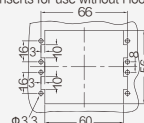

附件 Accessories

16A 冷压针 Crimp contacts

接触电阻 Contact resistance $\leq 1m\Omega$
镀银 Silver plated

公 Male	订货号 Part Number	母 Female	订货号 Part Number
CESM-0.37	09330006127	CESF-0.37	09330006227
CESM-0.5	09330006121	CESF-0.5	09330006220
CESM-0.75	09330006114	CESF-0.75	09330006214
CESM-1.0	09330006105	CESF-1.0	09330006205
CESM-1.5	09330006104	CESF-1.5	09330006204
CESM-2.5	09330006102	CESF-2.5	09330006202
CESM-3.0	09330006106	CESF-3.0	09330006206
CESM-4.0	09330006107	CESF-4.0	09330006207

镀金 Gold plated



公 Male	订货号 Part Number	母 Female	订货号 Part Number
CEGM-0.37	09330006117	CEGF-0.37	09330006217
CEGM-0.5	09330006122	CEGF-0.5	09330006222
CEGM-0.75	09330006115	CEGF-0.75	09330006215
CEGM-1.0	09330006118	CEGF-1.0	09330006218
CEGM-1.5	09330006116	CEGF-1.5	09330006216
CEGM-2.5	09330006123	CEGF-2.5	09330006223
CEGM-4.0	09330006119	CEGF-4.0	09330006221

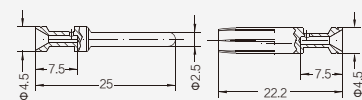

标示 Identification	线规 Wire gauge	剥线长度 Stripping length	
no groove	0.14-0.37mm ²	AWG 26-22	7.5mm
no groove	0.5mm ²	AWG 20	7.5mm
1 groove	0.75mm ²	AWG 18	7.5mm
1 groove	1.0mm ²	AWG 18	7.5mm
2 groove	1.5mm ²	AWG 16	7.5mm
3 groove	2.5mm ²	AWG 14	7.5mm
wide groove	3mm ²	AWG 12	7.5mm
no groove	4mm ²	AWG 12	7.5mm

工具 Tools

冷压钳 Crimping tool



压接线经 Wire gauge	型号 Type	订货号 Part Number
0.5-4mm ²	TL02G	09990000021

退针器 Removal tool



适用类型 For	型号 Type	订货号 Part Number
16A 冷压针 16A Crimp contacts	TL01	09990000059

更多工具请参考 25-01~25-02页 More tools on P25-01~P25-02